

FISSAGGIO CON BORSA LATERALE
FIXING WITH BAG

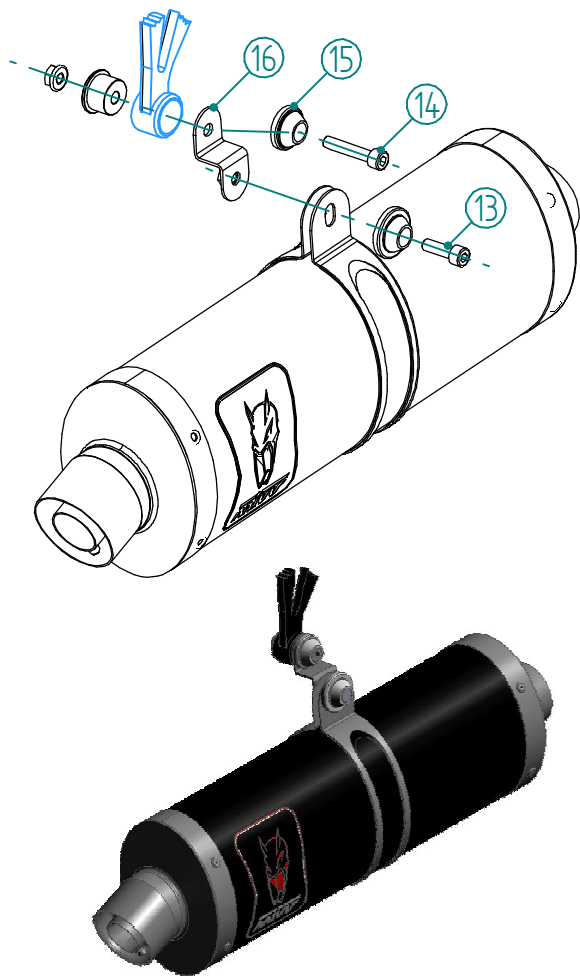

#	DESCRIPTION	PART NUMBER	QTY
13	Vite M8x25 / Screw M8x25	50.73.064.1	1
14	Vite M8x40 / Screw M8x40	50.73.075.1	1
15	Rondella in alluminio / Aluminium washer	50.73.291.1	1
16	Staffa / Bracket	50.SS.009.0	1

#	DESCRIPTION	PART NUMBER	QTY
1	Silenziatore / Muffler dB killer 50.DK.189.0	DAKAR 400	1
2	Protezione in gomma per staffa / Rubber protection for bracket	50.73.041.1	1
3	Staffa / Bracket	50.SS.002.0	1
4	Vite M8x65 / Screw M8x65	50.73.603.1	1
5	Rondella in alluminio / Aluminium washer	50.73.063.1	1
6	Distanziale in alluminio / Aluminium spacer (Øe.30 Øi.8,5 h.35)	50.SS.053.1	1
7	Bussola / Bush	50.73.713.0	1
8	Dado M8 flangiato / Flanged nut M8	50.73.393.1	1
9	Fascetta Ø 52/55 mm / Pipe clamp Ø 52/55 mm	50.FA.008.1	1
10	Tubo di raccordo / Link pipe	9773S058SE	1
11	Molla media / Mid-size spring	50.73.359.1	1
12	Tubo in gomma per molla / Rubber pipe for spring	50.73.210.1	1

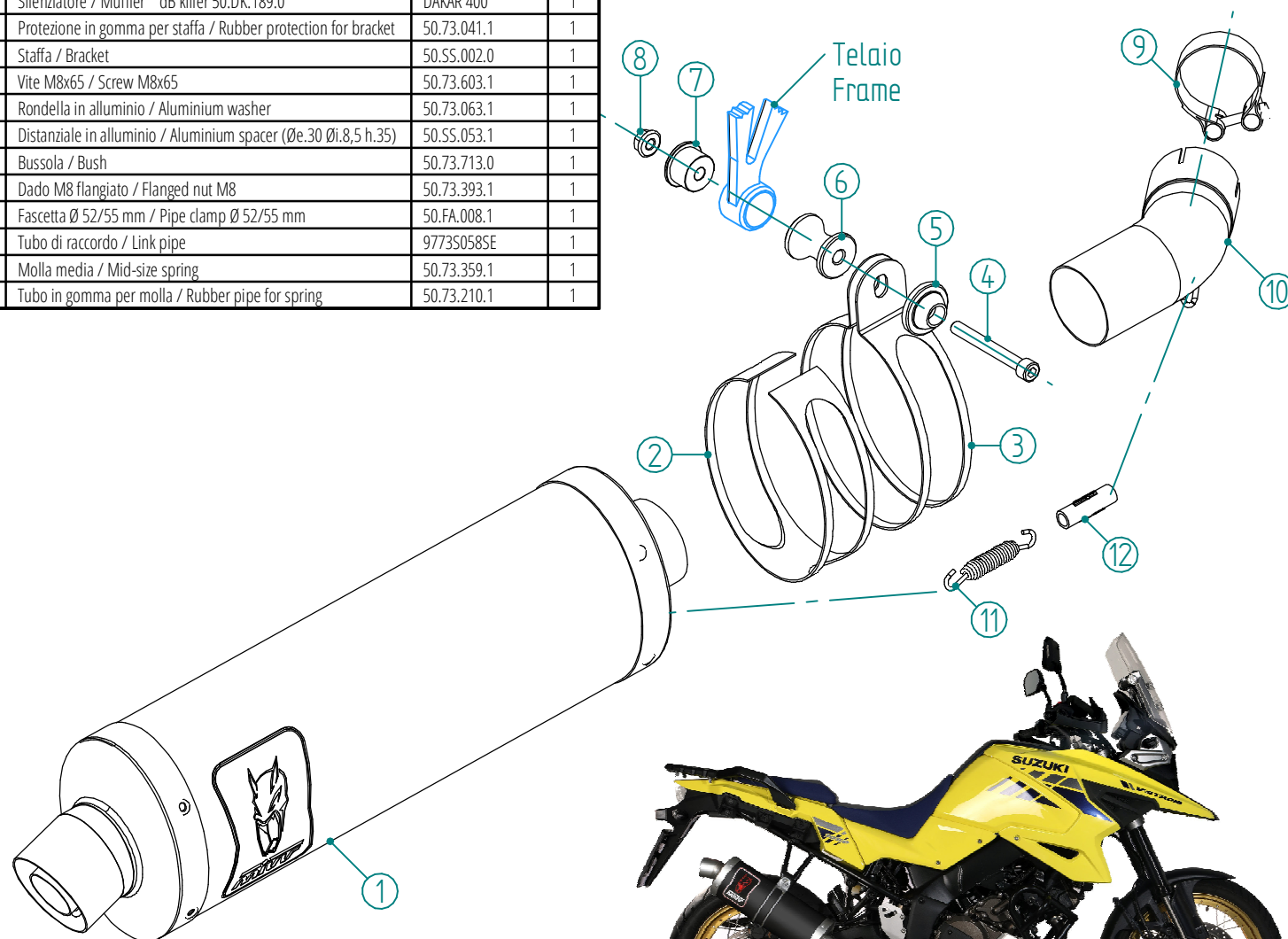

APPLICAZIONI / APPLICATIONS			
CODICE / CODE	SILENZIATORE / MUFFLER	TUBO / PIPE	FASCETTA / CLAMP
S.042.LEKB	STEEL BLACK	INOX / ST. STEEL	INOX / ST. STEEL